

JENSEN®

3-SPEED STEREO TURNTABLE WITH CD AND CASSETTE MUSIC SYSTEM



USER MANUAL JTA-475

PLEASE READ THIS USER MANUAL COMPLETELY BEFORE OPERATING THIS UNIT AND RETAIN THIS BOOKLET FOR FUTURE REFERENCE.

DEAR JENSEN® CUSTOMER

Selecting fine audio equipment such as the unit you've just purchased is only the start of your musical enjoyment. Now it's time to consider how you can maximize the fun and excitement your equipment offers. This manufacturer and the Electronic Industries Association's Consumer Electronics Group want you to get the most out of your equipment by playing it at a safe level. One that lets the sound come through loud and clear without annoying blaring or distortion and, most importantly, without affecting your sensitive hearing.

Sound can be deceiving. Over time your hearing "comfort level" adapts to higher volumes of sound. So what sounds "normal" can actually be loud and harmful to your hearing. Guard against this by setting your equipment at a safe level BEFORE your hearing adapts.

To establish a safe level:

- Start your volume control at a low setting.
- Slowly increase the sound until you can hear it comfortably and clearly, and without distortion.

Once you have established a comfortable sound level:

- Set the dial and leave it there.

Taking a minute to do this now will help to prevent hearing damage or loss in the future. After all, we want you listening for a lifetime.

We Want You Listening For a Lifetime

Used wisely, your new sound equipment will provide a lifetime of fun and enjoyment. Since hearing damage from loud noise is often undetectable until it is too late, this manufacturer and the Electronic Industries Association's Consumer Electronics Group recommend you avoid prolonged exposure to excessive noise.

Customer's Record:

The serial number of this product is found on its back cover. You should note the serial number of this unit in the space provided as a permanent record of your purchase to aid in identification in the event of theft or loss.

Model Number: JTA-475

Serial Number: _____

WARNING

TO PREVENT FIRE OR SHOCK HAZARD, DO NOT USE THIS PLUG WITH AN EXTENSION CORD, RECEPTACLE OR OTHER OUTLET UNLESS THE BLADES CAN BE FULLY INSERTED TO PREVENT BLADE EXPOSURE. TO PREVENT FIRE OR SHOCK HAZARD, DO NOT EXPOSE THIS APPLIANCE TO RAIN OR MOISTURE.



IMPORTANT SAFETY INSTRUCTIONS

1. Read these instructions - All the safety and operating instructions should be read before the appliance is operated
2. Keep these instructions - The safety and operating instructions should be kept for future reference.
3. Heed all warnings - All warnings on the appliance and in the operating instructions should be adhered to.
4. Follow all instructions - All operation and use instructions should be followed.
5. Do not use this apparatus near water - The appliance should not be used near water; for example, near a bathtub, washbowl, kitchen sink, laundry tub, in a wet basement, or near a swimming pool, and the like.
6. Clean only with dry cloth - The appliance should be cleaned only as recommended by the manufacturer.
7. Do not block any ventilation openings. Install in accordance with the manufacturer's instructions. - The appliance should be situated so that its location or position does not interfere with its proper ventilation. For example, the appliance should not be situated on a bed, sofa, rug, or similar surface that may block the ventilation openings; or placed in a built-in installation, such as a bookcase or cabinet that may impede the flow of air through the ventilation openings.
8. Do not install near any heat sources such as radiators, heat registers, stoves or other apparatus (including amplifiers) that produce heat.
9. Do not defeat the safety purpose of the polarized or grounding-type plug. A polarized plug has two blades with one wider than the other. A grounding type has two blades and a third grounding prong. The wide blade or the third prong are provided for your safety. If the provided plug does not fit into your outlet, consult an electrician for replacement of the obsolete outlet.
10. Protect the power cord from being walked on or pinched particularly at



plugs, convenience receptacles, and the point where they exit from the apparatus.

11. Only use attachments / accessories specified by the manufacturer
12. Use only with the cart, stand, tripod, bracket, or table specified by the manufacturer, or sold with the apparatus. When a cart is used, use caution when moving the cart/apparatus combination to avoid injury from tip-over.
13. Unplug this apparatus during lightning storms or when unused for a long periods of time.
14. Power Sources - The appliance should be connected to a power supply only of the type described in the operating instructions or as marked on the appliance. Do not overload wall outlet.
15. Wall and Ceiling Mounting - The appliance should be mounted to a wall or ceiling only as recommended by the manufacturer.
16. Power Lines - An outdoor antenna should be located away from power lines.
17. Outdoor Antenna Grounding - If an outside antenna is connected to the receiver, be sure the antenna system is grounded so as to provide some protection against voltage surges and built up static charges. Section 810 of the National Electrical Code, ANSI/ NFPA No.70-1984, provides information with respect to proper grounding of the mast and supporting structure, grounding of the lead-in wire to an antenna discharge unit, size of grounding conductors, location of antenna discharge unit, connection to grounding electrodes, and requirements for the grounding electrode. See figure 1.

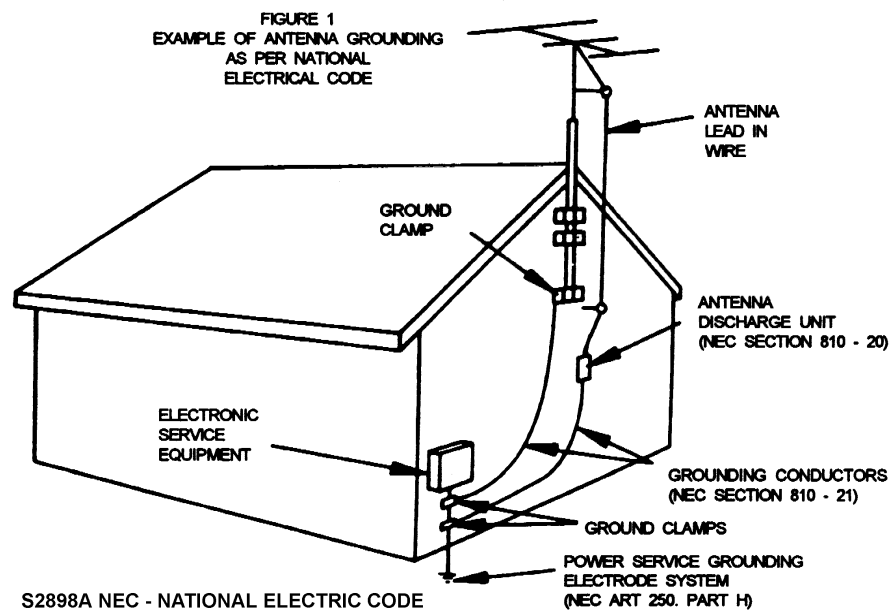

18. Object and Liquid Entry - Care should be taken so that objects do not fall and liquids are not spilled into the enclosure through openings.
19. Refer all servicing to qualified service personnel. Servicing is required when the apparatus has been damaged in any way, such as power-supply cord or plug is damaged, liquid has been spilled or objects have fallen into the apparatus, the apparatus has been exposed to rain or moisture, does not operate normally, or has been dropped.
20. Servicing - The user should not attempt to service the appliance beyond that described in the operating instructions. All other servicing should be referred to qualified service personnel.
21. The MAINS plug or an appliance coupler is used as the disconnect device, the disconnect device shall remain readily operable.
22. Battery pack or battery installed should not be exposed to excessive heat such as sunshine,

fire or the like.

23. Caution marking and nameplate are located on back of product.

Caution

Danger of explosion if battery is incorrectly replaced. Replace only with the same or equivalent type.

The apparatus shall not be exposed to dripping or splashing and that no objects filled with liquids, such as vases, shall be placed on apparatus.

CAUTION

TO PREVENT ELECTRIC SHOCK, MATCH WIDE BLADE OF PLUG TO WIDE SLOT. FULLY INSERT THE PLUG TO MAIN POWER SOCKET.

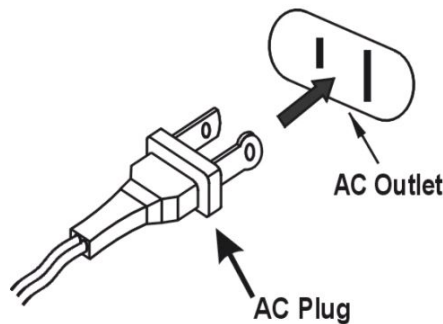

CAUTION

CLASS 1 LASER PRODUCT

CLASS 1 LASER PRODUCT
APPAREIL LASER DE CLASSE 1
PRODUCTO LASER DE CLASE 1

CAUTION
INVISIBLE LASER REDIATION
WHEN OPEN AND INTERLOCKS
DEFEATED
AVOID EXPOSURE TO BEAM.



This product contains a low power laser device.

Note: This product complies with DHHS Rule 21 Subchapter J at date of manufacture.

Follow the advice below for safe and appropriate operation.

ON PROTECTION AGAINST LASER ENERGY EXPOSURE

- As the laser beam used in this compact disc player is harmful to the eyes, do not attempt to disassemble the casing.
- Stop operation immediately if any liquid or solid object should fall into the cabinet.
- Do not touch the lens or poke at it. If you do, you may damage the lens and the player may not operate properly.
- Do not put anything in the safety slot. If you do, the laser diode will be ON when the CD door is still open.
- This unit employs a laser. The use of controls or adjustment or performance of procedures other than those specified here may result in exposure to hazardous radiation.

ON PLACEMENT

- Do not use the unit in places which are extremely hot, cold, dusty or humid.
- Place the unit on a flat and even surface.
- Do not restrict the air-flow of the unit by placing it in a place with poor ventilation, by covering it with a cloth or by placing it on a carpet.

ON CONDENSATION

- When left in a heated room where it is warm and damp, water droplets or condensation may form inside the unit.
- When there is condensation inside the unit, the unit may not function normally. Let it stand for 1 to 2 hours before turning the power on, or gradually heat the room up and dry the unit before use.

Should any trouble occur, remove the power source and refer servicing to qualified personnel.

PRECAUTION FORE USE

- **UNPACK ALL PARTS AND REMOVE PROTECTIVE MATERIAL.**
- **DO NOT CONNECT THE UNIT TO THE MAINS BEFORE CHECKING THE MAINS VOLTAGE AND ALL OTHER CONNECTIONS HAVE BEEN MADE.**
- **DO NOT COVER ANY VENTS AND MAKE SURE THAT THERE IS A SPACE OF SEVERAL CENTIMETERS AROUND THE UNIT FOR VENTILATION.**

IMPORTANT NOTES

Avoid installing the unit in locations described below:

- Places exposed to direct sunlight or close to heat radiating appliances such as electric heaters.
- Places subject to constant vibration.
- Dusty, humid or moist places.

PROTECT YOUR FURNITURE !!

This model is equipped with non-skid rubber 'feet' to prevent the product from moving when you operate the controls. These 'feet' are made from non-migrating rubber material specially formulated to avoid leaving any marks or stains on your furniture. However certain types of oil based furniture polishes, wood preservatives, or cleaning sprays may cause the rubber 'feet' to soften, and leave marks or a rubber residue on the furniture. To prevent any damage to your furniture we strongly recommend that you purchase small self-adhesive felt pads, available at hardware stores and home improvement centers everywhere, and apply these pads to the bottom of the rubber 'feet' before you place the product on fine wooden furniture.

COMPLIANCE WITH FCC REGULATIONS

This device complies with Part 15 of the FCC Rules. Operation is subject to the following two conditions:

- (1) this device may not cause harmful interference, and
- (2) this device must accept any interference received, including interference that may cause undesired operation.

NOTE : This equipment has been tested and found to comply with the limits for a Class B digital device, pursuant to Part 15 of the FCC Rules. These limits are designed to provide reasonable protection against harmful interference in a residential installation. This equipment generates, uses and can radiate radio frequency energy and, if not installed and used in accordance with the instructions, may cause harmful interference to radio communications. However, there is no guarantee that interference will not occur in a particular installation. If this equipment does cause harmful interference to radio or television reception, which can be determined by turning the equipment off and on, the user is encouraged to try to correct the interference by one or more of the following measures:

- Reorient or relocate the receiving antenna.
- Increase the separation between the equipment and receiver.
- Connect the equipment into an outlet on a circuit different from that to which the receiver is connected.
- Consult the dealer or an experienced radio/TV technician for help.

CAUTION: Changes or modifications not expressly approved by the party responsible for compliance could void the user's authority to operate the equipment.

GETTING START

SPEAKER CONNECTION

1. Insert the speaker cable ends (exposed wires) into the terminals located on the back of the main unit by pushing down the lever of the left speaker terminal and then the right speaker terminal
2. Connect the left speaker to the left speaker terminals with the red wire to L+ and the black wire to L -.
3. Connect the right speaker to the right speaker terminals with the red wire to R+ and the black wire to R -.

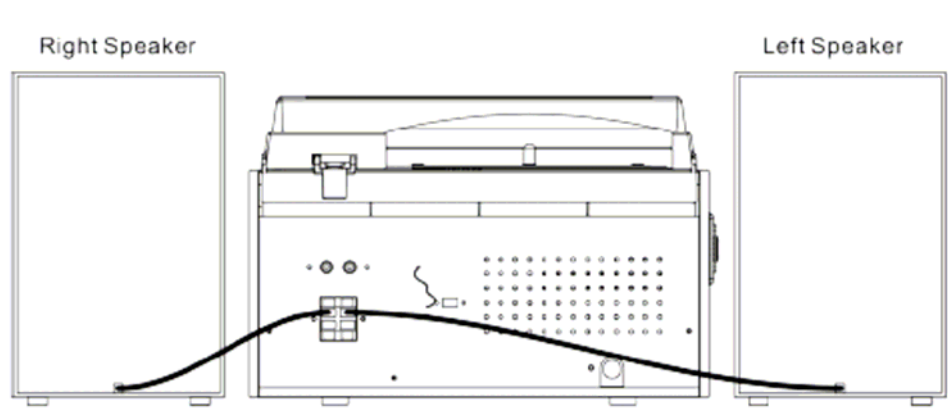

NOTE:

Make sure that the power is turned off when connecting or disconnecting the speakers. Make sure that the speakers are connected to the correct terminals.

CONNECTING THE AC POWER CORD

After connecting the speakers unwind the AC power cord fully and connect it to any convenient household 120V~ 60Hz AC outlet.

NOTE:

The product is designed to operate on normal 120V~ 60Hz AC only. Connecting this system to any other power supply could result in damage to the unit which is not covered by your warranty. You will notice that this system is equipped with a polarized AC power plug having one blade wider than the other. This is a safety feature.

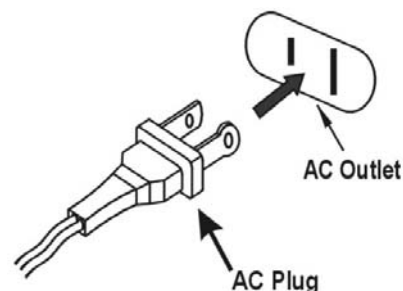

If this plug does not fit into your existing AC outlet, do not try to defeat this safety feature by filling the wide blade to make it fit into your outlet. If this plug will not fit into your outlet, you probably have an outdated non-polarized AC outlet. You should have your outlet changed by a qualified licensed electrician.

LOCATION OF CONTROLS AND INDICATORS

FRONT VIEW & BACK VIEW

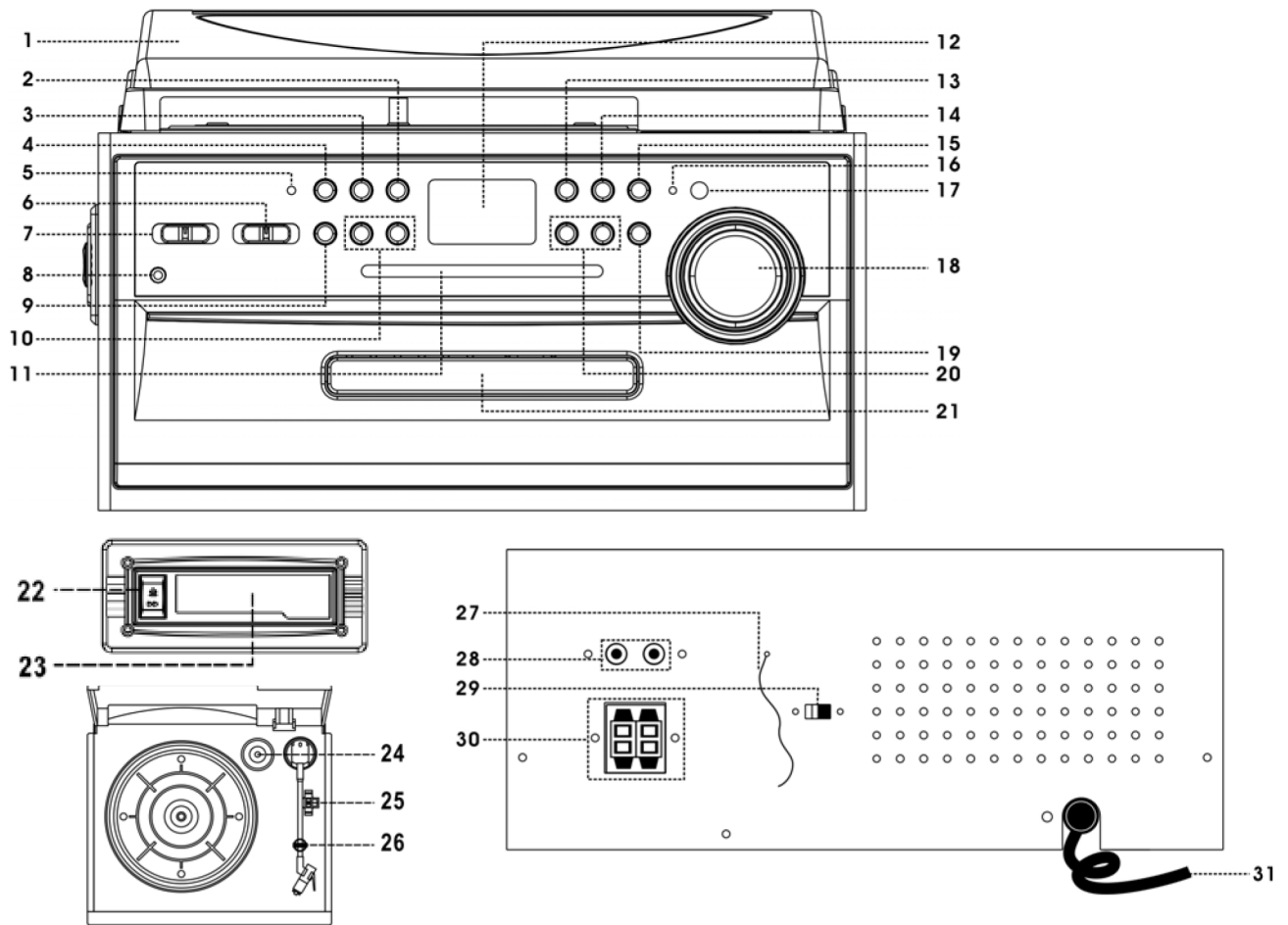

- | | |
|---------------------------------|---|
| 1.) DUST COVER | 17.) REMOTE SENSOR |
| 2.) REPEAT BUTTON | 18.) TUNING KNOB |
| 3.) RANDOM BUTTON | 19.) CD TRAY OPEN/CLOSE BUTTON |
| 4.) POWER ON/OFF BUTTON | 20.) CD SKIP/SEARCH FORWARD ►►
/BACKWARD ◀◀ BUTTON |
| 5.) POWER ON LED INDICATOR | 21.) CD TRAY |
| 6.) AM/FM/FM STEREO BAND SWITCH | 22.) TAPE FAST FORWARD / EJECT BUTTON |
| 7.) FUNCTION SWITCH | 23.) CASSETTE DUST COVER |
| 8.) 3.5MM STEREO HEADPHONE JACK | 24.) 45 RPM RECORD ADAPTOR |
| 9.) BASS BOOST ON/OFF BUTTON | 25.) 33/45/78 RPM SPEED SELECTOR |
| 10.) VOLUME + / - BUTTON | 26.) TONE ARM HOLDER |
| 11.) LED DIAL POINTER | 27.) FM WIRE ANTENNA |
| 12.) LCD DISPLAY (FOR CD ONLY) | 28.) RCA LINE OUT JACKS |
| 13.) CD PROGRAM BUTTON | 29.) TURNTABLE AUTO STOP SWITCH |
| 14.) CD STOP ■ BUTTON | 30.) SPEAKER WIRE TERMINAL |
| 15.) CD PLAY/PAUSE ► BUTTON | 31.) AC POWER CORD |
| 16.) FM STEREO LED INDICATOR | |

Remote Control (For CD Operation Only)

- 1) PROGRAM BUTTON
- 2) REPEAT/RANDOM BUTTON
- 3) SKIP/SEARCH FORWARD ►► BUTTON
SKIP/SEARCH BACKWARD ◄◄ BUTTON
- 4) CD TRAY OPEN.CLOSE ▲ BUTTON
- 5) PLAY/PAUSE ►|| BUTTON
- 6) STOP ■ BUTTON
- 7) VOLUME + / - BUTTON (For CD, Tape, Phono and Tuner)

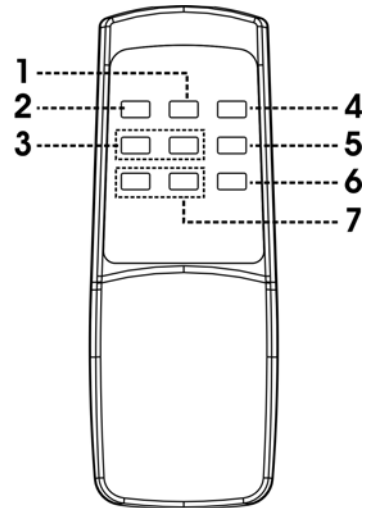

BATTERY INSTALLATION

- 1.) Open the battery compartment cover.
- 2.) Insert two "AAA" (UM-4) batteries (included) and observe the polarity as indicated inside the battery compartment when installing.
- 3.) Replace the cover.

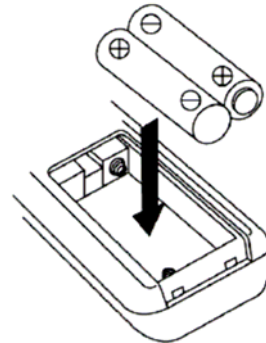

Battery Precautions

- Replacement of batteries must be done by an adult.
- Do not mix old and new batteries.
- Do not mix alkaline, standard (carbon-zinc) or rechargeable (nickel-cadmium) batteries.
- The supply terminals are not to be short-circuited.
- Non-rechargeable batteries are not to be recharged.
- Exhausted batteries are to be removed.
- Only batteries of the equivalent type are to be used.
- Batteries are to be inserted with the correct polarity.
- Dispose of batteries properly. Do not dispose of batteries in fire. The batteries may explode or leak.

OPERATING INSTRUCTIONS

LISTENING TO THE RADIO

- 1.) Press down the POWER button to turn the system "On", power LED indicator lights.
- 2.) Slide the FUNCTION selector to the TUNER (Radio) position.
- 3.) Slide the BAND selector to the desired band, AM, FM or FM STEREO.
- 4.) Tune to your desired station with the TUNING knob. If FM STEREO mode is selected and you tune to an FM Stereo station, the FM STEREO LED Indicator will light.
- 5.) Press and hold the VOLUME+/- buttons to adjust the volume level as desired.
- 6.) When you are finished listening, press the POWER button to turn the unit off.

Antenna Information

AM - The AM antenna is located inside the cabinet of the unit. If AM reception is weak, change the position of unit until the internal antenna picks up the strongest signal.

FM - For best FM reception, the FM lead wire antenna located on the back of the set should be fully unwound and extended. When an FM station is weak or distorted, listening is usually improved by switching the BAND selector to FM Mono mode.

PLAYING COMPACT DISCS

NOTE: This player will not only play commercial CDs, but also self-complied CD-D/RW discs.
Do not attempt to play CD-ROM, CDI, VCD, DVD or computer CDs.

Notes on CD-R/RW Discs

- Because of non-standardized format definition/production of CD-R/RW CD, playback quality & performance are not guaranteed.
- Manufacturer is not responsible for the playability of CD-R/RW CD due to recording conditions such as PC performance, writing software, media ability, etc.
- Do not attach a label or seal to either side of the CD-R/RW disc. It may cause a malfunction.

The following procedures can be accomplished by using the remote or controls on the unit.

LOADING THE DISCS

- 1.) Press down the POWER button to turn the system "On".
- 2.) Slide the FUNCTION selector to the CD position.
- 3.) Press the ▲ Open/Close button to open the CD tray.
- 4.) Insert a CD disc onto the tray.





- 5.) Press the  Open/Close button to close the CD tray. The CD player will read the disc and the display will show the number of total tracks.
- 6.) If a CD cannot be recognized by the player or if no disc is loaded, the display will show “-“.

NOTES:

- Keep the CD disc tray closed when the system is not in use to prevent dirt and dust from entering the CD mechanism.
- Never place more than one CD in the CD tray. If two discs are loaded at the same time, the CD mechanism may jam and / or the discs themselves may be damaged.

TO BEGIN CD PLAYBACK



After you have loaded the CD in the player:



- 1.) Press the  PLAY/PAUSE button to begin playback. The player will begin playback from Track 1 on the disc.
- 2.) Press and hold the VOLUME+/- buttons to adjust volume level as desired.
- 3.) To temporarily stop playback, press the  PLAY/PAUSE button again. The disc continues to spin, but no sound is heard. Press the  PLAY/PAUSE button once more to cancel pause and resume playback.
- 4.) To stop playback before the end of a disc, press the  STOP button.

IMPORTANT!!

If the disc is smudged or scratched it may skip or stop completely. This does not indicate a problem with the player. If this occurs, try playing another disc. If that disc plays properly, you may assume that the first disc is damaged and unplayable.

or SKIP/SEARCH Buttons

To skip forward or backward during playback, press the  or  SKIP/SEARCH buttons repeatedly until the desired track number appears on the display. Playback will begin on the desired track.

To search for a particular passage on a track during playback, press and hold the  or  SKIP/SEARCH buttons. The player will search rapidly forward or backward. Release the buttons when you reach the desired point on the track and normal speed playback will resume at that point.

PROGRAMMED CD PLAYBACK

The CD player can be programmed to play any sequence of up to 20 tracks.



- 1.) Press the  STOP button before starting the programming.

- 2.) After the disc loads, press the PROGRAM button. The “PROG.” indicator will appear flashing on the display. The display shows program track “01” and then changes to flashing “00” to prompt you enter the CD track to be programmed.
- 3.) Select the desired track number by pressing the ►► or ◀◀ SKIP/SEARCH buttons.
- 4.) Press PROGRAM button to confirm the track number. Program track advanced to “02” and then display shows “00” and flashing to prompt you enter another CD track.
- 5.) Repeat above steps 3-4 until you have stored up to 20 tracks in the program memory.
- 6.) Press the ►|| PLAY/PAUSE button to begin programmed playback. Playback will (up to total of 20) have been played.
- 7.) Press the ■ STOP button to stop programmed tracks playback. Press the ►|| PLAY/PAUSE button will resume normal playback.

NOTE: If you press ►► or ◀◀ SKIP/SEARCH buttons during programmed playback, the player will skip forward or backward to the next track that was programmed, and not to the next track in sequence on the disc that is being played.

REPEAT Playback

This system has a repeat function which allows you to continuously repeat one track, or all tracks.

Select the track to be repeated and begin playback. Press the REPEAT button, “Repeat 1” indicator  will light on the display and the selected track will be repeated continuously. Press the REPEAT button again, “Repeat All” indicator  will light on, the entire track will be repeated continuously. Press REPEAT button until the “Repeat” indicator disappears to resume to normal playback.

RANDOM Playback

Press the RANDOM button before or during playback, “RAN.” indicator will light on the display. Then, all the tracks in the CD will be played in random order. Switch off random playback function by pressing the RANDOM button again and the “RAN.” indicator will go out.

REPEAT/RANDOM Playback by Remote Control

Press the REPEAT/RANDOM button on the remote control before or during playback, REPEAT and RANDOM function will switch as the below sequence:



STEREO PHONOGRAPH OPERATION

NOTE, BEFORE USE:

- Remove the stylus protector.
- Be sure that the tone arm is detached from the tone arm rest before operating, and replace again when finished.

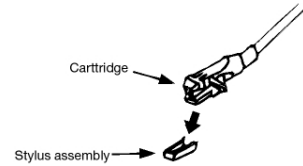

- 1.) Press down the POWER button to turn the system "On".
- 2.) Slide the FUNCTION selector to the PHONO position.
- 3.) Raise the turntable dust cover.
- 4.) Release the tone arm clamp and remove the stylus protector.
- 5.) Place a record on the platter, over the center spindle (use the 45 RPM record adaptor when playing 45 RPM record).
- 6.) Set the Speed selector to 33, 45 or 78 rpm according to the record you are playing.
- 7.) Lift the tone arm from the rest and slowly move it over the record. The platter will begin to turn.
- 8.) Move the tone arm to the beginning of the record, or to the start of a particular track. Gently lower the tone arm onto the record to start playing.
- 9.) Press and hold the VOLUME+/- buttons to adjust volume level as desired.
- 10.) When the record is played to the end of the record, the platter will automatically stop rotating. Lift the tone arm and return it to the rest position.
- 11.) To stop the record manually when playing, lift up the tone arm and return it to the rest position.

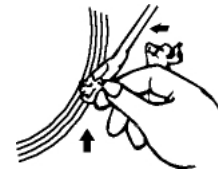

REMARK: Some types of records may have an auto-stop area outside the preset limit, so the turntable may stop before the last track finishes. In this case, set the auto-stop switch to the "OFF" position. This allows the record to play to the end, but it will not stop automatically. You must manually raise the tone arm and place it back in the rest to stop the turntable from spinning and turn it off.

CASSETTE TAPE OPERATION

- 1.) Press down the POWER button to turn the system "On".
- 2.) Slide the FUNCTION selector to the TAPE position.
- 3.) The system will start playback automatically after inserting the cassette tape.
- 4.) Press and hold the VOLUME+/- buttons to adjust volume level as desired.
- 5.) Press the TAPE FAST FORWARD / EJECT button half way when playing, the tape will be advanced forward rapidly.
- 6.) Slightly press the TAPE FAST FORWARD / EJECT button again to resume normal

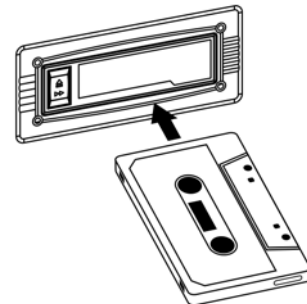

playback. The button will resume to the outermost position.

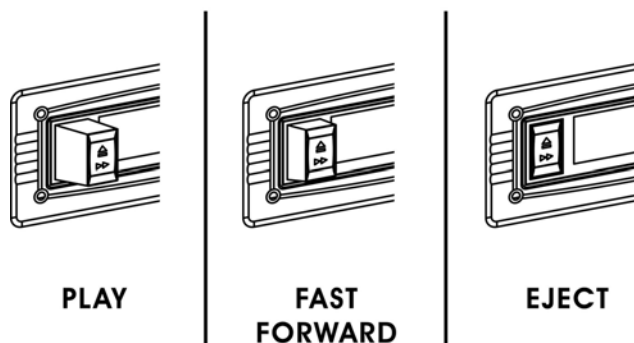

7.) Press the TAPE FAST FORWARD / EJECT button completely, then the playing will be stopped and the cassette tape will be ejected.

REMARK:

- Make sure the direction is correct when inserting the tape.
- To avoid damaging the tape, it is recommended to take the cassette tape out of the deck after listening.

BASS BOOST

Press down the “BASS BOOST” button on the main unit if you want to enhance the bass when listening to the system. Press the button again to turn off bass boost effect.

LINE OUT CONNECTION

You can connect this unit to your external Hi-Fi / AMPLIFIER system by connecting the LINE OUT socket to the auxiliary input socket of your Hi-Fi / AMPLIFIER system with RCA cables (not included).

Note: The Volume control of the main unit will not function when using the LINE OUT.

3.5MM STEREO HEADPHONE JACK

The stereo headphone jack is located on the left front panel. Plug a set of stereo headphones (not included) into this jack for private listening without disturbing others. The speakers are automatically disconnected when headphones are connected to the jack.

IMPORTANT: When using headphones, always set the volume control to a low level before you put the headphone on. Then put the headphone on and gradually increase the volume to a comfortable listening level.

CARE AND MAINTAINENCE

1. Do not subject the unit to excessive force, shock, dust or extreme temperatures.
2. Do not tamper with the internal components of the unit.
3. Clean the unit with a dry cloth. Solvents or detergents should never be used.
4. Avoid leaving the unit in direct sunlight or in hot, humid or dusty places.
5. Keep the unit away from heating appliances and sources of electrical noise such as fluorescent lamps or motors.

CASSETTE CARE

Two common causes of trouble experienced when using cassettes are:

- 1) Tape Jamming – Leading to uneven speed in playback, and
- 2) Tape Tangling – Where the tape wraps itself around internal parts of the mechanism.

To reduce the likelihood of these problems occurring, the following precautions should be observed:

- Check that there are no loose layers of tape visible through the cassette center window (see Fig. 1). Take up any loose layers, using a pencil or hexagonal barrelled ballpoint pen, before inserting the cassette into the machine (see Fig.2)
- If the cassette feels tight while performing operation shown (see Fig.2), the tape may be jamming due to ridges formed in the winding of the tape (visible through the center window). These may be removed, in most cases, by fast winding of the cassette from one end to the other and back again.
- Use only well-known brands of tape. Avoid use of C-120 cassettes.

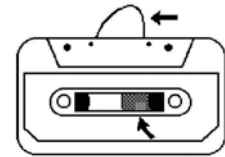

Fig.1

Furthermore, do not expose cassettes to direct sunlight, dust or oil, and do not touch the tape surfaces.

COMPACT DISC CARE

- Handle the disc only by its edges. Never allow your fingers to come in contact with the shiny, unprinted side of the disc.
- Do not attach adhesive tape, stickers etc., to the disc label.
- Clean the disc periodically with soft, lint-free, dry cloth. Never use detergents or adhesive cleaners to clean the disc. If necessary, use a CD cleaning kit.
- If disc skips or gets stuck on a section of the disc, it is probably dirty or damaged (scratched).
- When cleaning the disc, wipe in straight lines from the center of the disc to the edge of the disc. Never wipe in circular motions.
- To remove a disc from its storage case, press down on the center of the case and lift the disc out, holding it carefully by the edges.
- Fingerprints and dust should be carefully wiped off the disc's recorded surface with a soft cloth. Unlike conventional records, compact discs have no grooves to collect dust and microscopic debris so gently wiping with a soft cloth should remove most particles.



CLEANING THE UNIT

- To prevent fire or shock hazard, disconnect your unit from the AC power source when cleaning.
- The finish on the unit may be cleaned with a dust cloth and cared for as other furniture, Use caution when cleaning and wiping the plastic parts.
- If the cabinet becomes dusty wipe it with a soft dry dust cloth. Do not use any wax or polish sprays on the cabinet.
- If the front panel becomes dirty or smudged with fingerprints it

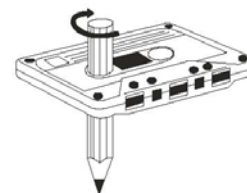

Fig. 2

may be cleaned with a soft cloth slightly dampened with a mild soap and water solution. Never use abrasive cloths or polishes as these will damage the finish of your unit.

CAUTION: Never allow any water or other liquids to get inside the unit while cleaning.

TROUBLESHOOTING GUIDE

Symptom	Possible Problem	Solution
The unit does not respond (no power).	AC cord is not plugged into a wall outlet	Plug the AC cord into a wall outlet.
	Wall outlet is not functioning.	Plug another device into the same outlet to confirm the outlet is working.
AM band is too noisy.	The reception at the set location is poor.	Slightly rotate the unit for the best reception.
Sound is distorted.	Volume level is set too high.	Decrease the volume.
	Sound source is distorted.	Try a different audio source such as a music CD.
CD Player does not play.	CD mode is not selected.	Slide the FUNCTION switch to select CD mode.
	CD is not installed or installed incorrectly.	Press the CD onto spindle, printed side facing up.
CD skips while playing.	Disc is dirty or scratched.	Wipe with cloth or another disc.
Unit gets warm after extended play at high volume.	This is normal.	Turn the unit off a period of time or lower volume.

SPECIFICATION

Power Requirement

Main unit: AC120V~ 60Hz

Remote control: 2 x 1.5V "AAA" (UM-4) size batteries (included)

Frequency Range

Radio Band: FM 88 ~ 108 MHz
AM 530 ~ 1710 KHz

Power Consumption

Main Unit: 18Watts



At Spectra, environmental and social responsibility is a core value of our business. We are dedicated to continuous implementation of responsible initiatives with an aim to conserve and maintain the environment through responsible recycling.

Please visit us at <http://www.spectraintl.com/green.htm> for more information on Spectra's green initiatives or to find a recycler in your area.

**90 DAY LIMITED WARRANTY AND SERVICE
VALID IN THE U.S.A ONLY**

SPECTRA MERCHANDISING INTERNATIONAL, INC. warrants this unit to be free from defective materials or factory workmanship for a period of 90 days from the date of original customer purchase and provided the product is utilized within the U.S.A. This warranty is not assignable or transferable. Our obligation under this warranty is the repair or replacement of the defective unit or any part thereof, except batteries, when it is returned to the SPECTRA Service Department, accompanied by proof of the date of original consumer purchase, such as a duplicate copy of a sales receipt.

You must pay all shipping charges required to ship the product to SPECTRA for warranty service. If the product is repaired or replaced under warranty, the return charges will be at SPECTRA's expense. There are no other express warranties other than those stated herein.

This warranty is valid only in accordance with the conditions set forth below:

1. The warranty applies to the SPECTRA product only while:
 - a. It remains in the possession of the original purchaser and proof of purchase is demonstrated.
 - b. It has not been subjected to accident, misuse, abuse, improper service, usage outside the descriptions and warnings covered within the user manual or non-SPECTRA approved modifications.
 - c. Claims are made within the warranty period.
2. This warranty does not cover damage or equipment failure caused by electrical wiring not in compliance with electrical codes or SPECTRA user manual specifications, or failure to provide reasonable care and necessary maintenance as outlined in the user manual.
3. Warranty of all SPECTRA products applies to residential use only and is void when products are used in a nonresidential environment or installed outside the United States.

This warranty gives you specific legal rights, and you may also have other rights which vary from state to state. TO OBTAIN SERVICE please remove all batteries (if any) and pack the unit carefully and send it freight prepaid to SPECTRA at the address shown below. IF THE UNIT IS RETURNED WITHIN THE WARRANTY PERIOD shown above, please include a proof of purchase (dated cash register receipt) so that we may establish your eligibility for warranty service and repair of the unit without cost. Also include a note with a description explaining how the unit is defective. A customer service representative may need to contact you regarding the status of your repair, so please include your name, address, phone number and email address to expedite the process.

IF THE UNIT IS OUTSIDE THE WARRANTY PERIOD, please include a check for \$50.00 to cover the cost of repair, handling and return postage. All out of warranty returns must be sent prepaid.

It is recommended that you contact SPECTRA first at 1-800-777-5331 or by email at custserv@spectraintl.com for updated information on the unit requiring service. In some cases the model you have may be discontinued, and SPECTRA reserves the right to offer alternative options for repair or replacement.

SPECTRA MERCHANDISING INTERNATIONAL, INC.
4230 North Normandy Avenue,
Chicago, IL60634, USA.
1-800-777-5331

To register your product, visit the link on the website below to enter your information.
<http://www.spectraintl.com/wform.htm>

Printed in China